

**Manual**  
**Knife Mill Grindomix GM200**

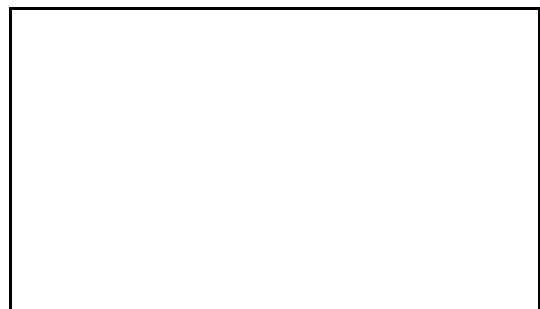

Translation



**Copyright**

© Copyright by  
Retsch GmbH  
Rheinische Strasse 36  
D-42781 Haan  
Federal Republic of Germany

<b>1</b>	<b>Notes on the Operating Manual</b> .....	<b>5</b>
1.1	Explanations of the safety warnings .....	6
1.2	General safety instructions .....	7
1.3	Repairs.....	8
<b>2</b>	<b>Confirmation</b> .....	<b>9</b>
<b>3</b>	<b>Transport, scope of delivery, installation</b> .....	<b>10</b>
3.1	Packaging .....	10
3.2	Transport.....	10
3.3	Temperature fluctuations and condensed water .....	10
3.4	Conditions for the place of installation .....	10
3.5	Installation of the machine .....	10
3.6	Electrical connection .....	10
3.7	Type plate description.....	11
<b>4</b>	<b>Technical data</b> .....	<b>12</b>
4.1	Use of the machine for the intended purpose.....	12
4.2	Working instructions .....	12
4.3	Protective equipment .....	13
4.4	Drive output.....	13
4.5	Rated power .....	13
4.6	Motor rotation speed.....	13
4.7	Rated voltage.....	13
4.8	Emissions.....	13
4.8.1	Noise measurement Example 1:.....	14
4.8.2	Noise measurement Example 2:.....	14
4.9	Degree of protection .....	14
4.10	Dimensions and weight.....	14
4.11	Required floor space.....	15
<b>5</b>	<b>Operating the machine</b> .....	<b>16</b>
5.1	Views of the Instrument .....	16
5.2	Overview table of the parts of the device .....	18
5.3	Overview Table of the Operating Elements and the Display.....	19
5.4	Operating the Device .....	20
5.5	Switching On and Off.....	20
5.6	Opening and closing of the grinding chamber .....	20
5.7	Inserting the grinding jar .....	21
5.8	Use of grinding jugs depending on different materials .....	21
5.8.1	Grinding jars – plastic jugs (PP) .....	22
5.8.2	Grinding jars – glass jugs (borosilicate glass 3.3) .....	22

5.8.3	Grinding jars – stainless steel jugs .....	22
5.9	Lid and jug combinations .....	22
5.9.1	Lid 1000ml .....	22
5.9.2	Lid 500ml .....	23
5.9.3	Gravitation lid .....	23
5.10	Filling the vessel .....	24
5.10.1	Filling – within the device .....	24
5.10.2	Filling – outside the device .....	25
5.11	Setting the grinding time .....	26
5.12	Setting the Speed .....	27
5.13	Switching on interval or continuous mode .....	27
5.14	Reverse grinding.....	28
5.15	Store functions .....	29
5.15.1	Saving programs.....	29
5.15.2	Starting a saved program .....	29
5.16	Start – Pause – Stop.....	29
5.16.1	Pause function .....	29
5.16.2	Premature termination of grinding .....	29
5.17	Resetting the overload protection .....	29
<b>6</b>	<b>Cleaning and service .....</b>	<b>30</b>
<b>7</b>	<b>Fault messages.....</b>	<b>30</b>
<b>8</b>	<b>Disposal.....</b>	<b>31</b>
<b>9</b>	<b>Index .....</b>	<b>32</b>

## 1 Notes on the Operating Manual

This operating manual is a technical guide on how to operate the device safely and it contains all the information required for the areas specified in the table of contents. This technical documentation is a reference and instruction manual. The individual chapters are complete in themselves.

Familiarity (of the respective target groups defined according to area) with the relevant chapters is a precondition for the safe and appropriate use of the device.

This operating manual does not contain any repair instructions. If faults arise or repairs are necessary, please contact your supplier or get in touch with Retsch GmbH directly.

Application technology information relating to samples to be processed is not included but can be read on the Internet on the respective device's page at [www.retsch.com](http://www.retsch.com).

### **Changes**

Subject to technical changes.

### **Copyright**

Disclosure or reproduction of this documentation, use and disclosure of its contents are only permitted with the express permission of Retsch GmbH.

Infringements will result in damage compensation liability.

## 1.1 Explanations of the safety warnings

In this Operating Manual we give you the following safety warnings

---

**Serious injury** may result from failing to heed these safety warnings. We give you the following warnings and corresponding content.

---

 **WARNING**

**Type of danger / personal injury**

Source of danger

- Possible consequences if the dangers are not observed.
  - **Instructions on how the dangers are to be avoided.**
- 

We also use the following signal word box in the text or in the instructions on action to be taken:

 **WARNING**

---

**Moderate or mild injury** may result from failing to heed these safety warnings. We give you the following warnings and corresponding content.

---

 **CAUTION**

**Type of danger / personal injury**

Source of danger

- Possible consequences if the dangers are not observed.
  - **Instructions on how the dangers are to be avoided.**
- 

We also use the following signal word box in the text or in the instructions on action to be taken:

 **CAUTION**

---

In the event of possible **property damage** we inform you with the word “Instructions” and the corresponding content.

---

*NOTICE*

**Nature of the property damage**

Source of property damage

- Possible consequences if the instructions are not observed.
  - **Instructions on how the dangers are to be avoided.**
- 

We also use the following signal word in the text or in the instructions on action to be taken:

*NOTICE*

## 1.2 General safety instructions

 **CAUTION**

**Read the Operating Manual**

Non-observance of these operating instructions

- The non-observance of these operating instructions can result in personal injuries.
- **Read the operating manual before using the device.**
- **We use the adjacent symbol to draw attention to the necessity of knowing the contents of this operating manual.**



**Target group :** All persons concerned with the machine in any form

This machine is a modern, high performance product from Retsch GmbH and complies with the state of the art. Operational safety is given if the machine is handled for the intended purpose and attention is given to this technical documentation.

You, as the owner/managing operator of the machine, must ensure that the people entrusted with working on the machine:

- have noted and understood all the regulations regarding safety,
- are familiar before starting work with all the operating instructions and specifications for the target group relevant for them,
- have easy access always to the technical documentation for this machine,
- and that new personnel before starting work on the machine are familiarised with the safe handling of the machine and its use for its intended purpose, either by verbal instructions from a competent person and/or by means of this technical documentation.

Improper operation can result in personal injuries and material damage. You are responsible for your own safety and that of your employees.

Make sure that no unauthorised person has access to the machine.

 **CAUTION**

**Changes to the machine**

- Changes to the machine may lead to personal injury.
- **Do not make any change to the machine and use spare parts and accessories that have been approved by Retsch exclusively.**

*NOTICE*

**Changes to the machine**

- The conformity declared by Retsch with the European Directives will lose its validity.
- You lose all warranty claims.
- **Do not make any change to the machine and use spare parts and accessories that have been approved by Retsch exclusively.**

### 1.3 Repairs

This operating manual does not contain any repair instructions. For your own safety, repairs may only be carried out by Retsch GmbH or an authorized representative or by Retsch service engineers.

**In that case please inform:**

The Retsch representative in your country
Your supplier
Retsch GmbH directly

**Your Service Address:**



## 2 Confirmation

This operating manual contains essential instructions for operating and maintaining the device which must be strictly observed. It is essential that they be read by the operator and by the qualified staff responsible for the device before the device is commissioned. This operating manual must be available and accessible at the place of use at all times.

The user of the device herewith confirms to the managing operator (owner) that (s)he has received sufficient instructions about the operation and maintenance of the system. The user has received the operating manual, has read and taken note of its contents and consequently has all the information required for safe operation and is sufficiently familiar with the device.

As the owner/managing operator you should for your own protection have your employees confirm that they have received the instructions about the operation of the machine.

I have read and taken note of the contents of all chapters in this operating manual as well as all safety instructions and warnings.

**User**

Surname, first name (block letters)

Position in the company

Signature

**Service technician or operator**

Surname, first name (block letters)

Position in the company

Place, date and signature

### 3 Transport, scope of delivery, installation

#### 3.1 Packaging

The packaging has been adapted to the mode of transport. It complies with the generally applicable packaging guidelines.

#### 3.2 Transport

---

##### *NOTICE*

###### **Transport**

- Mechanical or electronic components may be damaged.
  - **The machine may not be knocked, shaken or thrown during transport.**
- 

#### 3.3 Temperature fluctuations and condensed water

---

##### *NOTICE*

###### **Temperature fluctuations**

The machine may be subject to strong temperature fluctuations during transport (e.g. aircraft transport)

- The resultant condensed water may damage electronic components.
  - **Protect the machine from condensed water.**
- 

#### 3.4 Conditions for the place of installation

---

##### *NOTICE*

###### **Ambient temperature**

- Electronic and mechanical components may be damaged and the performance data alter to an unknown extent.
  - **Do not exceed or fall below the permitted temperature range of the machine (5°C to 40°C / ambient temperature).**
- 

#### 3.5 Installation of the machine

Installation height: maximum 2000 m above sea level

#### 3.6 Electrical connection

- Please check the type plate for details on the necessary voltage and frequency for the device.
- Make sure the levels agree with the existing mains power supply.
- Use the supplied connection cable to connect the device to the mains power supply.



When connecting the power cable to the mains supply, use an external fuse that complies with the regulations applicable to the place of installation .

**3.7 Type plate description**

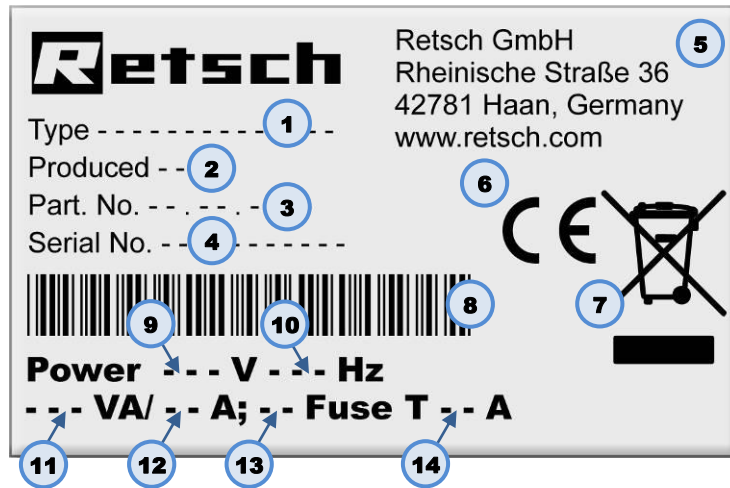

Fig. 1: Type plate lettering

- 1 Device designation
- 2 Year of production
- 3 Part number
- 4 Serial number
- 5 Manufacturer's address
- 6 CE marking
- 7 Disposal label
- 8 Bar code
- 9 Power version
- 10 Mains frequency
- 11 Capacity
- 12 Amperage
- 13 Number of fuses
- 14 Fuse type and fuse strength

In the case of questions please provide the device designation (1) or the part number (2) and the serial number (3) of the device.

## 4 Technical data

### 4.1 Use of the machine for the intended purpose

 **CAUTION**

**Risk of explosion or fire**

Changing sample characteristics

- Note that the characteristics and accordingly the danger presented by a sample can change during sieving.
- **Do not sieve any potentially explosive or combustible materials in this device.**

 **CAUTION**

**Risk of explosion or fire**

- On account of its design, the device is not suitable for use in hazardous (potentially explosive) atmospheres.

- **Do not operate the device in a hazardous atmosphere.**

 **CAUTION**

**Danger of personal injury**

Dangerous nature of the sample

- Depending on the dangerous nature of your sample, take the necessary measures to rule out any danger to persons.
- **Observe the safety guidelines and datasheets of your sample material.**



**Target group:** operators

**Machine type designation:** GM 200

This device is suitable for analytical grinding, homogenisation and mixing of soft to medium-hard, aqueous, fatty, fibrous and dry materials in seconds. This device is designed for quantities of approximately 700ml, large volume materials up to 1000ml.

The feed size is < 30 - 40 mm.

The device is specially designed for the grinding of the following materials :

Fish, meat, vegetables, cheese, preserves, seeds, bacon, sausage, dry baked goods and pastries, all aqueous, fatty and fibrous products and similar materials.

The device is designed as a laboratory device for 8-hour one-shift operation with a 30% ON duration.

It is not intended for use as production machine and not intended for the mixing and homogenisation of liquids with low viscosity (emulsions and suspensions) .

### 4.2 Working instructions

The grinding process of the device is effected through cutting and, in reverse operation, through impact effect.

The cutters are straight and are arranged at right-angles to the direction of rotation.

The cutters are slim with a cutting angle of 15° and a pre-cut (pre-grind) of 30°.

With this cutting geometry the entire inertia resulting from the speed difference between the sample material particles and the cutters can be used as cutting force.

The speed is between 2000 - 10000min<sup>-1</sup> and is altered in stages of 500min<sup>-1</sup> and displayed digitally.

The preselected speed is kept constant during grinding by a speed regulator.

Interval operation has proved to be advantageous in the pre-grinding and homogenisation of large-piece, tough, fibrous and very soft and elastic products.

The grinding duration can be set up to 3 minutes. After expiry of the grinding duration the motor automatically switches off and the housing lid opens.

3 memories permit the storage and retrieval of frequently used speed/time combinations by the press of a button.

### 4.3 Protective equipment

The grinding chamber of this device is interlocked by a resistant protective hood.

It is only possible to start the device when the protective hood is closed. The motor must have come to a standstill to open the device.

In the event of fault there is also an electric emergency brake which brings the cutters to a standstill in fractions of a second from the highest speed.

If the achievable current speed deviates from the setpoint speed by more than 5% due to an overload, this is shown by flashing displays.

### 4.4 Drive output

Universal electric motor

### 4.5 Rated power

Motor performance: approx. 1000 watts

### 4.6 Motor rotation speed

Speed: 2000 rpm<sup>-1</sup>.... 10,000 rpm<sup>-1</sup> ( can be altered in steps of 500 Umin<sup>-1</sup>)

### 4.7 Rated voltage

Rated voltages:	230 V	50 Hz	(+/- 5%)
	100-120V	50/60 Hz	(+/- 5%)

### 4.8 Emissions



**Possibility of acoustic signals not being heard**

Loud grinding noises

- Acoustic alarms and voice communication might not be heard.

- **Consider the volume of the grinding noise in relation to other acoustic signals in the work environment. You may wish to use additional visual signals.**

Noise values: ~ 56 dB(A) (without sample material, beaker, cutters)

Noise measurement in accordance with DIN 45635-031-01-KL3

The noise values are also influenced by the properties of the sample medium.

**4.8.1 Noise measurement Example 1:**

Intensity of sound LWA

Workplace-related emission value LpAeq

*Operating conditions:*

Jug = glass jug with gravitation lid

Grind unit = cutter made of stainless steel

Feed material = tomatoes, quartered approx. 40 x 25mm

Feed quantity = 100g

**4.8.2 Noise measurement Example 2:**

Intensity of sound LWA

Workplace-related emission value LpAeq

*Operating conditions:*

jug = glass jug with gravitation lid

Grind unit = cutter made of stainless steel

Feed material = cheese approx. 20 x 20mm

Feed quantity = 100g

**4.9 Degree of protection**

- Grinding chamber and keypad - IP 42
- In the area of the ventilation slits - IP 20

**4.10 Dimensions and weight**

**Closed:**

Height: up to approx. 390mm

Width: 350mm

Depth : 250mm

**with open hood:**

Height: up to approx. 540mm

Width: 350mm

Depth : 410mm

Weight: approx. 10.1kg (without plastic container and cutter)

#### **4.11 Required floor space**

200 mm x 400 mm; no safety distances required.

## 5 Operating the machine

### 5.1 Views of the Instrument

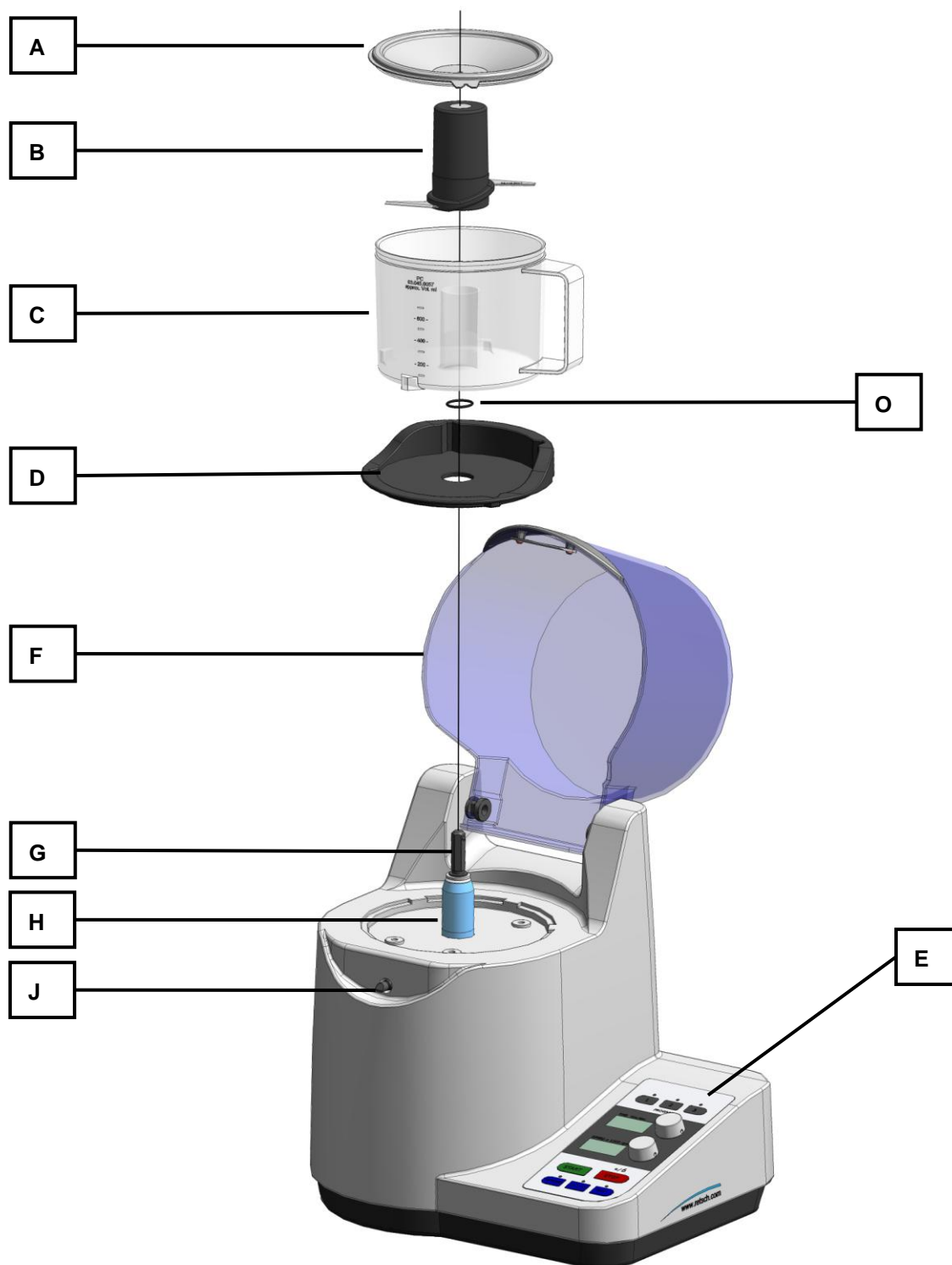

Fig. 2: Front view of the machine





Fig. 3: Rear view of the machine

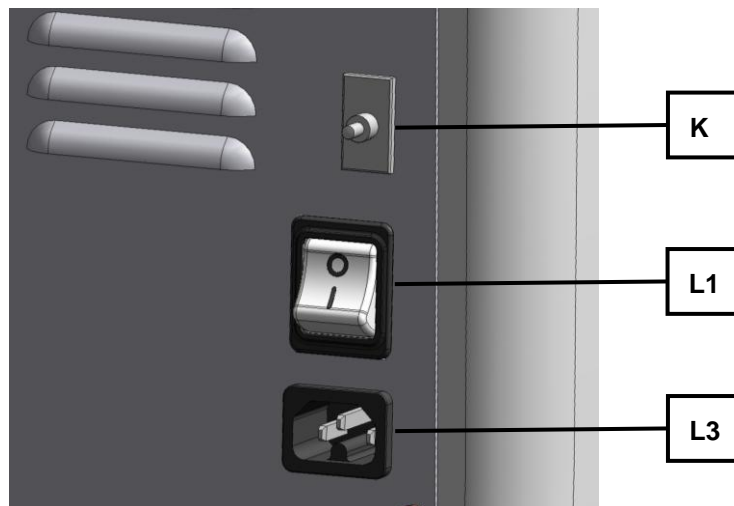

Fig. 4: Detail view of the socket for non-heating apparatus

## 5.2 Overview table of the parts of the device

Element	Description	Function
<b>A</b>	Jar lid	Seals the grinding jar
<b>B</b>	Knife cylinder	Cuts and grinds the sample material
<b>C</b>	Grinding jar	Holds the sample material
<b>D</b>	Jar holder	Holder for the grinding jar
<b>E</b>	Operating panel with displays	Start / stop / program memory and displays
<b>F</b>	Grinding chamber hood	Protective hood for safe grinding operations
<b>G</b>	Pin for knife cylinder	Drive shaft for knife cylinder
<b>H</b>	Support for grinding jar	Centres the grinding jar and the jar holder
<b>J</b>	Grinding chamber hood interlock	Locks the grinding chamber hood into place
<b>K</b>	Thermal fuse	Protective switch against overheating
<b>L1</b>	On/off switch	Separates the machine completely from the mains
<b>L3</b>	Socket for non-heating apparatus	Connection for mains cable
<b>M</b>	Vent	Ventilation of motor and inside chamber
<b>O</b>	O ring	Fixes the grinding chamber holder

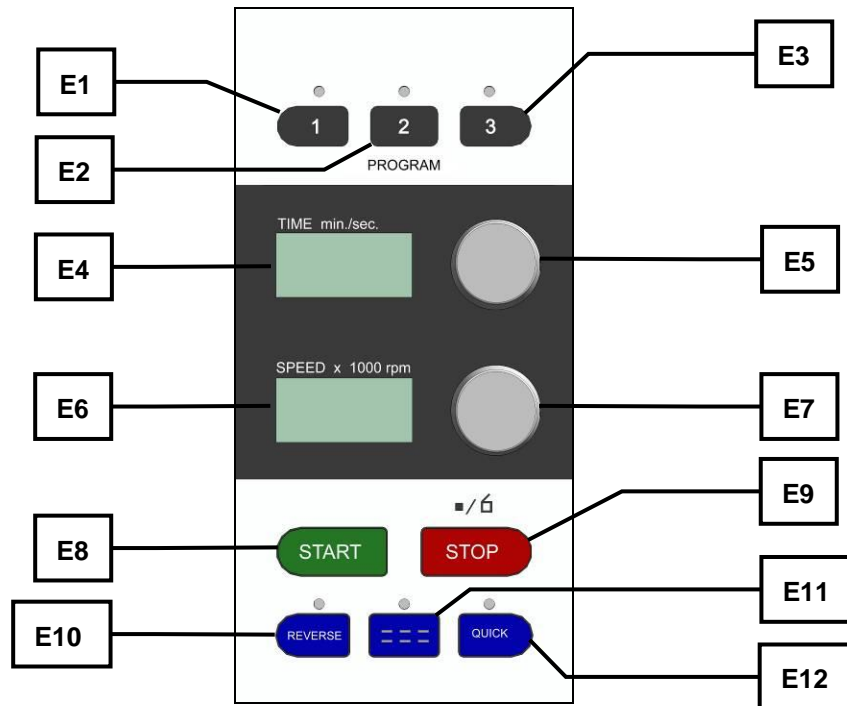

Fig. 5: Operating elements and displays

### 5.3 Overview Table of the Operating Elements and the Display

Element	Description	Function
E1	Program 1	Memory for program function
E2	Program 2	Memory for program function
E3	Program 3	Memory for program function
E4	Time display	Display of the remaining grinding time
E5	Time knob	Grinding time setting (1 second to 3 minutes)
E6	Speed display	Display of the set speed
E7	Speed knob	Speed setting
E8	START button	Start of grinding
E9	STOP / open button	End of grinding / opening of the protective hood
E10	REVERSE button	Direction reversal
E11	INTERVAL button	Grinding with short intervals
E12	QUICK button	Manually controlled grinding

## 5.4 Operating the Device

 **CAUTION**

**Device falling down**

Incorrect assembly or unsuitable workplace

- The appliance is very heavy and can therefore cause serious personal injuries if it falls down.

- **Operate the device only on a sufficiently large, firm, skid-resistant and steady workplace.**

- **Make sure that all equipment feet are steady.**

 **CAUTION**

**Damage to hearing**

The level of noise can be high depending on the type of material, the knife used, the speed set and the duration of the grinding process.

- Noise that is excessive in terms of level and duration can cause impaired or permanently damaged hearing.

- **Ensure suitable sound-proofing measures or wear hearing protection.**



## 5.5 Switching On and Off

The main switch is located on the reverse side of the device (L1).

- Switch the main switch on.

The grinding time last used appears in the TIME display.

The speed last used appears in the SPEED display.

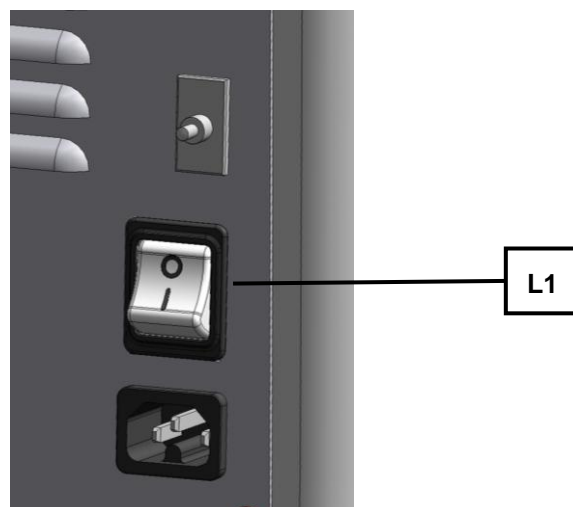

Fig. 6: Main switch

## 5.6 Opening and closing of the grinding chamber

 **CAUTION**

**Crushed or bruised fingers**

Falling grinding chamber protective hood

- The protective hood of the grinding chamber can cause crushed or bruised fingers if it falls down.
- **Hold the flap tight when closing.**

- Briefly press the STOP button (E9).
- The hood is unlocked and opens.

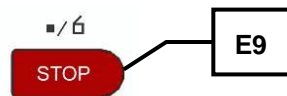

Fig. 7: Opening hood

**5.7 Inserting the grinding jar**

- Open the hood.
- Insert the jug.

Pay attention to the position of the jug when it is inserted.

N.B.

Ensure the correct position of the O ring (O).

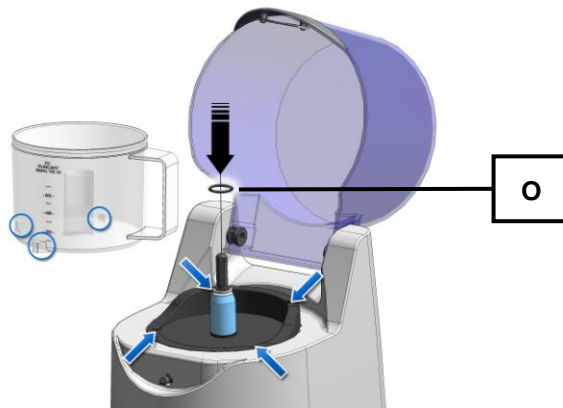

Fig. 8: Inserting jug

**5.8 Use of grinding jugs depending on different materials**

NOTE

The plastic jug, the plastic lid and the cutter are only dishwasher resistant.

- Pay attention to the position of the parts in the dishwasher.
- Do not place the plastic jug, the plastic lid or the cutter near to the heating coil. Otherwise, deformations cannot be ruled out and the parts can no longer be used.

Sterilisation by autoclaving is not basically possible.

1.H0052

### NOTICE

Grinding with liquid nitrogen (LN<sub>2</sub>) or dry ice (CO<sub>2</sub>) is not permitted in any variation of the GM.

Danger from brittleness and breakage of grinding tools or the glass and plastic containers.

#### 5.8.1 Grinding jars – plastic jugs (PP)

**Suitable** for the following sample materials:

soft, medium-hard, elastic, aqueous, fatty and oily.

**Unsuitable** for the following sample materials:

hard, hard-brittle,

e.g. cereals, pellets, gelatine sweets.

(increased friction in the plastic jug)

#### 5.8.2 Grinding jars – glass jugs (borosilicate glass 3.3)

**Suitable** for the following sample materials:

soft, medium-hard, elastic, aqueous, fatty and oily.

**Unsuitable** for the following sample materials:

hard, hard-brittle,

e.g. cereals, pellets, gelatine sweets.

(glass jugs can break)

#### 5.8.3 Grinding jars – stainless steel jugs

**Suitable** for the following sample materials:

soft, medium-hard, elastic, aqueous, fatty and oily, hard to medium-hard

e.g. cereals, frozen food, sweets, hard cheese and cold meat/sausage products

### 5.9 Lid and jug combinations



#### CAUTION

1.V0028

#### **Danger of injuries caused by cuts**

Moving parts – jug, rotor and grinding jar lid

- The jug and the rotor may fall down after removal and cause injury.
- **Be aware and put down the components safely.**
- **Do not place any objects on the device.**

The different lid / jug combinations will accommodate the different tasks.

### NOTE

Pay attention to the maximum feed quantity of 300ml.

In the case of aqueous materials the jug may otherwise overflow during grinding.

**Exceeding the non-recommended feed quantities.**

#### 5.9.1 Lid 1000ml

The 1000ml lid is used for larger quantities of small-piece material. The feed quantity ranges between 300 and a maximum of 700ml.

The lid is snapped on to the edge of the jug and can be released again by pulling up the flap.

**NOTE**

The 1000ml lid may be used both on the plastic and on the glass jug.

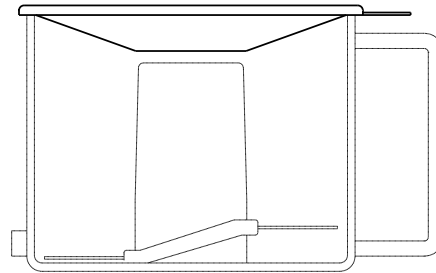

Fig. 2: 1000ml lid

**5.9.2 Lid 500ml**

The 500ml lid is used for smaller quantities of small-piece material. The feed quantity is a maximum of 300ml, depending on the material to be ground.

- Position the 500ml lid such that the edge is over the top edge of the jug.

During grinding the 500ml lid is held down by the hood.

**NOTE**

The 500ml lid can only be used with the plastic jug.

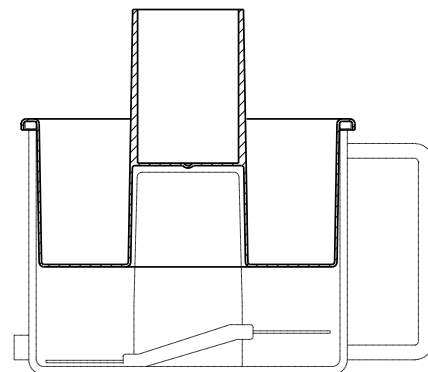

Fig. 3: 500ml lid

**5.9.3 Gravitation lid**

The gravitation lids permit an exact adjustment of the useful volume to the respective feed quantity. They move downwards during grinding, thereby optimising the grinding chamber volume. The feed quantity is a maximum of 300ml.

The gravitation lid with overcurrent channels ( ↗ ) is used for aqueous materials.

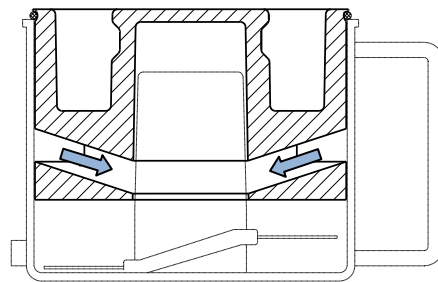

Fig. 4: Gravitation lid with overcurrent channels

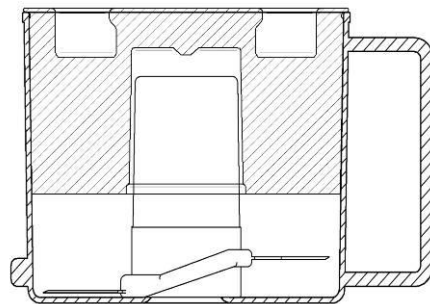

Fig. 5: Gravitation lid

NOTE

The gravitation lids for the plastic jug differ from the gravitation lids for the glass and steel grinding jugs.

## 5.10 Filling the vessel



**CAUTION**

2.V0039

**Danger of injuries caused by cuts**

Sharp cutters

- The cutters are very sharp and may lead to injuries caused by cuts if handled incorrectly.
- **Do not directly take hold of the cutters.**
- **Only reach into the grinding jar if it is outside the device.**
- **Do not reach into the grinding jar if the sample material still covers the cutter.**
- **Before taking out the cutter remove as much sample material to safely grip the cutter.**

NOTE

3.H0054

The hood must safely latch into the interlock pin so that the motor can start or so that no emergency brake is triggered during grinding.

Insert the cutter cylinder before adding the sample material because otherwise it may fall between cutter cylinder and jug.

### 5.10.1 Filling – within the device

- Insert the jug.



- Position the cutter cylinder and push it down as far as it will go.
- Add the sample material.
- Put on the lid.
- Close the hood until it latches into the interlock pin (J).

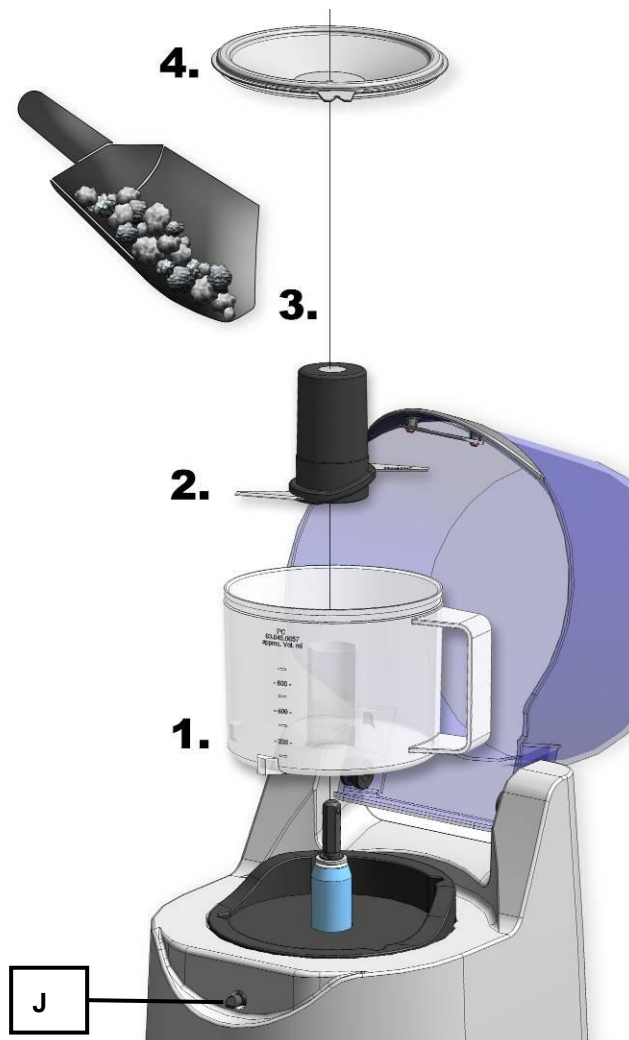

Fig. 6: Filling inside the device

### 5.10.2 Filling – outside the device

The jug can also be filled before positioning in the device. This means that you can work without problem with several jugs without intermediate cleaning.

The jugs can only be charged outside the machine with the 500ml and 1000ml lids; the gravitation lid is not suitable for this purpose.

- Place the cutter cylinder into the jug.
- Add the sample material.
- Position the lid.
- Press the lid in the centre downwards and place the jug into the device.

In the case of the 500ml lid it is essential to push it down so that the cutter cylinder reaches its final position.

Do not use the gravitation lid when filling the jug outside the machine since otherwise the cutter will not interlock.

- Close the hood until it latches in the interlock pin.

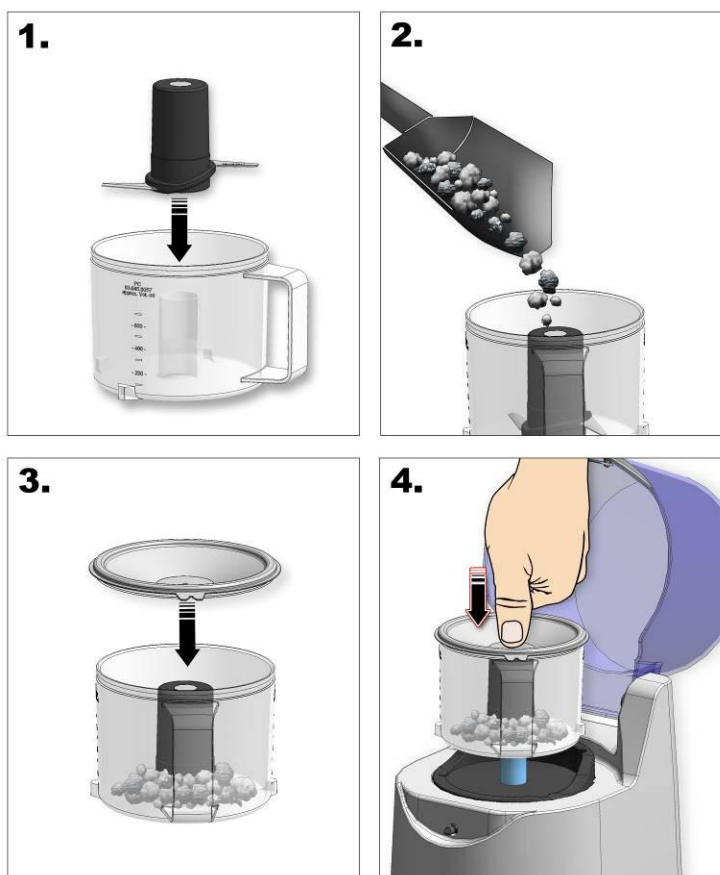
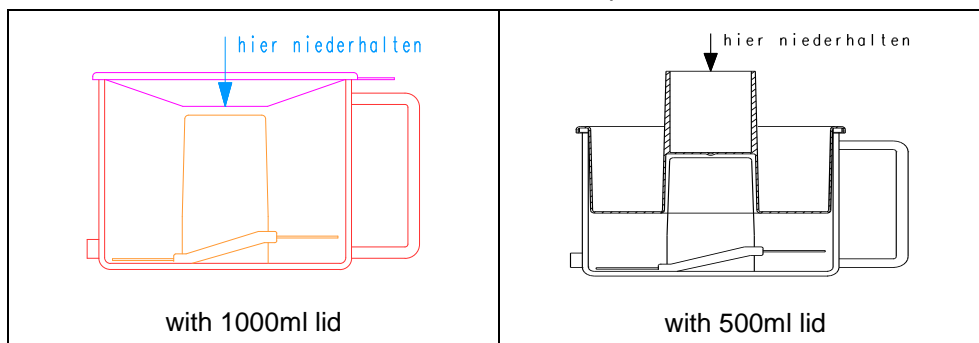

Fig. 7: Filling outside the device

### 5.11 Setting the grinding time

The grinding duration can be set from 1 second to 3 minutes in steps of 1 second.

- Turn the knob (E5) to the left to reduce the grinding duration.
- Turn the knob (E5) to the right to increase the grinding duration.

Turning slowly increases the time in steps of 1 second.

Turning quickly increases the grinding duration in steps of 1 minute.

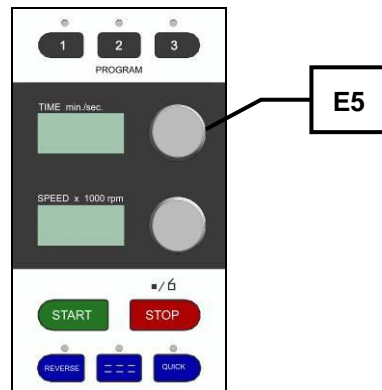

Fig. 8: Setting grinding duration

### 5.12 Setting the Speed

The speed can be set from 2000 min<sup>-1</sup> to 10.000 min<sup>-1</sup> in steps of 500 min<sup>-1</sup>.

- Turn the knob (E7) to the left to reduce the speed.
- Turn the knob (E7) to the right to increase the speed.

Slow turning alters the speed in steps of 500 min<sup>-1</sup>.

Fast turning alters the speed in steps of 3000 min<sup>-1</sup>.

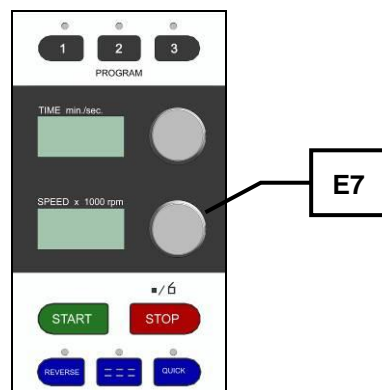

Fig. 9: Setting the speed

### 5.13 Switching on interval or continuous mode

- Press the interval button (E11).

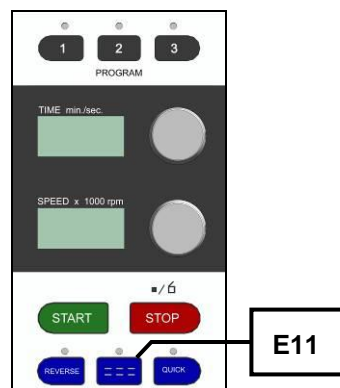

Fig. 10: Switching on interval operation

The LED over the button lights up. The set speed is shown in the display if it is not larger than 4000 rpm.

- Press the START button.

Grinding now takes places in the interval mode.

- To end interval grinding press the interval button (**E11**) once again.

The LED above the interval button goes out and the speed maintains the value of 4000 rpm. The device is in continuous mode again .

### 5.14 Reverse grinding

- Press the REVERSE button (**E10**).

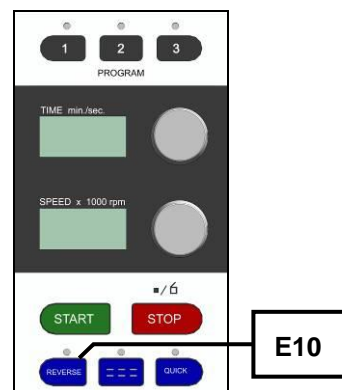

Fig. 11: Switching on interval operation

The LED above the REVERSE button lights up.

- Press the START button.

Grinding takes place in reverse mode and the motor runs against the cutting direction. Grinding takes place by impact unlike normal mode (cutting).

- Press the REVERSE button (**E11**) to leave the reverse mode again.

The LED above the REVERSE button lights up. The device is in normal mode once again – grinding by cutting .

- Press the QUICK button (**E12**).

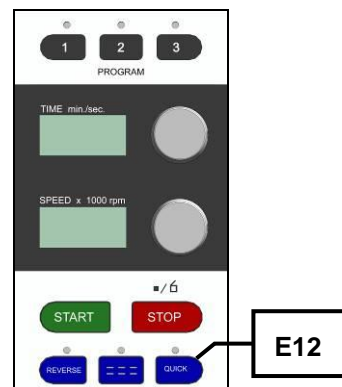

Fig. 12: QUICK grinding

The LED above the button lights up and grinding starts immediately.

- Release the QUICK button, grinding is ended immediately and the LED above the button goes out.

## 5.15 Store functions

### 5.15.1 Saving programs

- Keep the button **E1**, **E2** or **E3** pressed until the segment displays no longer flash.

The values for time and speed as well as the setting for REVERSE and INTERVAL operation are stored in the memory of the corresponding button.

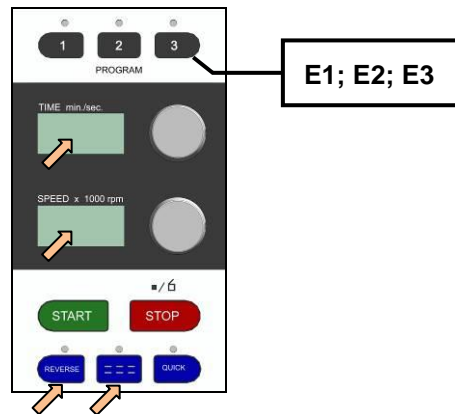

Fig. 13: Memory buttons

### 5.15.2 Starting a saved program

- Press the **E1**, **E2** or **E3** button.

The last saved values appear on the “TIME“ and “SPEED“ segment displays. The LEDs above the REVERSE and INTERVAL buttons light up depending on default.

Press the START button to start grinding with the default parameters.

## 5.16 Start – Pause – Stop

### 5.16.1 Pause function

- Press the STOP button during grinding.

Grinding is interrupted and the hood remains closed.

It is not possible to move the set parameters (speed, time, interval, reverse). The current time display is suspended.

- Press the START button to continue grinding.

Grinding is restarted and the time display runs again.

### 5.16.2 Premature termination of grinding

- Press the STOP button during grinding.

Grinding is interrupted and the hood remains closed.

- Press the STOP button again.

The device is switched off and the hood opens automatically. The parameters chosen for grinding (speed, time, interval, reverse) are displayed.

## 5.17 Resetting the overload protection

The overload protection switch (**K**) is situated on the rear panel.

This overload protection switch disconnects the device from the power supply if the machine is overloaded.

- After allowing the device to cool down it can be used with the power supply again by pressing the overload protection switch (**K**).

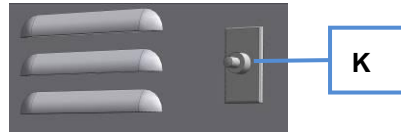

Fig. 14: Overload protection switch

## 6 Cleaning and service

**WARNING**

**Risk of a fatal electric shock**

- An electric shock can cause injuries in the form of burns and cardiac arrhythmia, respiratory arrest or cardiac arrest.
- **Do not clean the blender under running water. Use only a cloth dampened with water.**
- **Disconnect the power supply plug before cleaning the blender.**

## 7 Fault messages

F01	Motor is not running	
F02	Motor is switched off due to overload	Restart grinding process with small feed quantity.
F03	Motor speed too low / high	
F04	Hood open	
F05	Braking time too high	
F06	Motor overheated	Allow motor to cool and restart.
F07	Hood monitoring defective	Check the fault message: Press the START button when the hood is open. The "time" and "speed" segment displays flash evenly. Close the hood to rectify fault.
F08	Overspeed through hardware	

## 8 Disposal

Please observe the respective statutory requirements with respect to disposal.

Information on disposal of electrical and electronic machines in the European Community.

Within the European Community the disposal of electrically operated devices is regulated by national provisions that are based on the EU Directive 2002/96/EC on Waste Electrical and Electronic Equipment (WEEE).

Accordingly, all machines supplied after 13.08.2005 in the business-to-business area to which this product is classified, may no longer be disposed of with municipal or household waste. To document this they have the following label:

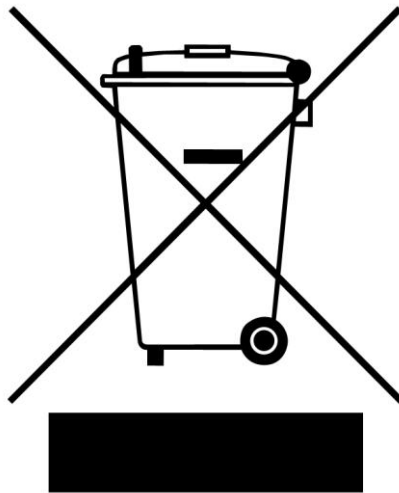

Fig. 15: Disposal label

Since the disposal regulations within the EU may differ from country to country we would request you to consult your supplier.

## 9 Index

<b>1</b>		<b>E</b>	
1000ml lid .....	23	elastic .....	22
<b>5</b>		Electrical connection .....	10
500ml lid .....	23	Emissions .....	13
<b>A</b>		Emulsions .....	12
Amperage .....	11	Explanations of the safety warnings .....	6
aqueous .....	22	External fuse .....	11
<b>B</b>		<b>F</b>	
Bar code .....	11	F01 .....	30
Borosilicate glass .....	22	F02 .....	30
<b>C</b>		F03 .....	30
Capacity .....	11	F04 .....	30
CE marking .....	11	F05 .....	30
Changes .....	5	F06 .....	30
Cleaning and service .....	30	F07 .....	30
Conditions for the place of installation .....	10	F08 .....	30
Confirmation .....	9	fatty .....	22
Connection cable .....	10	Fault messages .....	30
Continuous grinding .....	28	Feed size .....	12
Continuous mode .....	28	Filling – outside the device .....	25
Copyright .....	5	Filling – within the device .....	24
<b>D</b>		Filling inside the device .....	25
dB(A) .....	14	Filling outside the device .....	26
Degree of protection .....	14	Filling the vessel .....	24
Detail view of the socket for non-heating apparatus .....	17	Front view of the machine .....	16
Device designation .....	11	Fuse strength .....	11
Dimensions and weight .....	14	Fuse type .....	11
DIN 45635-031-01-KL3 .....	14	<b>G</b>	
Disposal .....	31	General safety instructions .....	7
Disposal label .....	11	Glass jugs .....	22
Disposal label .....	31	Gravitation lid .....	23, 24
Drive output .....	13	<b>H</b>	
		hard .....	22
		hard-brittel .....	22



<b>I</b>		<b>P</b>	
Inserting jug .....	21	Packaging .....	10
Inserting the grinding jar .....	21	Part number .....	11
Installation height .....	10	Pausen function .....	29
Installation of the machine .....	10	Plastic jugs .....	22
Interval grinding .....	28	Power version .....	11
<b>L</b>		Premature termination of grinding .....	29
Lid 1000ml .....	22	property damage .....	6
Lid 500ml .....	23	Protective equipment .....	13
Lid and jug combinations .....	22	<b>Q</b>	
LWA .....	14	QUICK grinding .....	28
<b>M</b>		<b>R</b>	
Main switch .....	20	Rated power .....	13
Mains frequency .....	11	Rated voltage .....	13
Manufacturer's address .....	11	Rear view of the machine .....	17
Materials .....	12	Regulations for the place of installation .....	11
medium-hard .....	22	Repairs .....	8
Memory buttons .....	29	Required floor space .....	15
Moderate or mild injury .....	6	Resetting the overload protection .....	29
Motor rotation speed .....	13	Reverse grinding .....	28
<b>N</b>		<b>S</b>	
Noise measurement .....	14	Safety warnings .....	6
noise values .....	14	Sample materials .....	22
Notes on the Operating Manual .....	5	Saving programs .....	29
Number of fuses .....	11	Serial number .....	11
<b>O</b>		serious injury .....	6
oily .....	22	Service Address .....	8
Opening and closing of the grinding chamber .....	20	Setting grinding duration .....	27
Opening hood .....	21	Setting the grinding time .....	26
Operating elements and displays .....	19	Setting the speed .....	27
Operating the Device .....	20	Setting the Speed .....	27
Operating the machine .....	16	soft .....	22
Overcurrent channels .....	24	Sound level .....	14
Overload protection switch .....	30	Stainless steel jugs .....	22
Overview Table of the Operating Elements and the Display .....	19	Start – Pause – Stop .....	29
Overview table of the parts of the device .....	18	Starting a saved program .....	29
		Sterilisation .....	21
		Store functions .....	29

Suspensions .....	12
Switching On and Off.....	20
Switching on interval operation.....	27, 28
Switching on interval or continuous mode .....	27

## **T**

Target group .....	7
Technical data .....	12
Temperature fluctuation and condensed water ..	10
Transport .....	10
Transport, scope of delivery, installation .....	10
Type plate .....	10
type plate description.....	11
Type plate lettering .....	11

## **U**

Use of grind jugs depending on different materials .....	21
Use of the machine for the intended purpose....	12

## **V**

Views of the Instrument .....	16
Viscosity .....	12

## **W**

Working instructions.....	12
Workplace-related emission value .....	14

## **Y**

Year of production.....	11
-------------------------	----